

RICOH

R8

Firmware Update Instruction Manual

This manual explains the procedures for downloading the R8 firmware from the Ricoh website and updating the camera's firmware.

Perform the following operations to update the firmware.

1. Check the firmware version



Caution

Before updating, be sure to check the firmware version through the following method. If the installed firmware is the latest version, there is no need to update.

1. Making sure that the camera's power is turned off, switch the mode dial to SCENE.

2. While pressing the ADJ./OK button ▼, hold down the  (Playback) button for 2-3 seconds.

- The firmware version will be displayed on the picture display for about 20 seconds.

3. Check the firmware version displayed on the picture display.

- e.g. When the firmware version is V1.00, the version will be shown as [MAIN : V 1.00] as follows:

```
MAIN : V 1.00  
BKUP : V X.XX  
MONI : V X.XX  
ADJD : V X.XX  
EXTD : V X.XX  
CPU1 : V X.XX  
SH : XXXXXX  
ST : XXXXXX
```

 (Playback) Button Mode dial

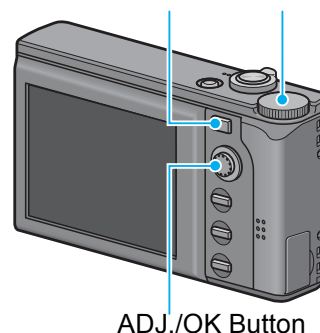

ADJ./OK Button

2. Extract the firmware

1. Download the firmware from the Ricoh website.
2. Double-click or right-click and select [Open] on the downloaded file.
 - A dialog screen appears.
3. Click [OK].
 - The folder [R8 Update] is created, and the firmware is extracted to the folder [Firmware relX.XX (where X.XX is the version number)]. Check that [zlaunch3] (firmware file) and [zlaunch7] (adjusted value file) are inside the folder [Firmware relX.XX].

For Windows

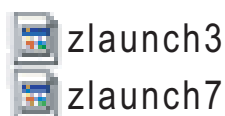

For Macintosh

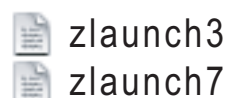

3. Copy the firmware to an SD memory card

There are two ways to copy the firmware into an SD memory card.

- With an SD memory card loaded in the camera, connect the camera and computer with the provided USB cable, and copy the firmware to the SD memory card
- Using a card reader or a card writer, copy the firmware to an SD memory card (a card reader or card writer is required)

To copy the firmware by connecting the camera and computer with the USB cable

1. If Caplio Software is installed on your Windows PC, check that RICOH Gate La is not active.
2. If RICOH Gate La is active, right-click on the RICOH Gate La icon in the task bar, and click [Exit].
 - If the RICOH Gate La icon is not displayed in the task bar, you do not need to perform Step 2.
3. Load a battery with adequate remaining power into the camera.
4. Load the SD memory card into the camera, and turn the power on.
5. Display the camera's Setup menu, select [Format [Card]], and press the ADJ./OK button ►.

6. Select [Yes], and press the ADJ./OK button.

- The SD memory card is formatted.

Caution

If you format a card that still has images stored on it, the images will be lost. Save the images you do not want to erase in your computer before formatting the card.

7. Turn the camera off, and connect the camera and computer with the provided USB cable.

- The camera turns on automatically. If the camera does not turn on automatically, press the POWER button and turn the power on.
- If Caplio Software is installed in your Windows PC, RICOH Gate La may automatically start up. In this case, exit RICOH Gate La.
- Click [Cancel] if the [Removable Disk] dialog appears in Windows XP or Windows Vista.
- If iPhoto starts up in Mac OS X, exit iPhoto.

8. Copy the files [zlaunch3] and [zlaunch7] (created when the firmware was extracted) into [RICOHDCX] in [My Computer].

- The camera's drive name may differ depending on the OS you are running. e.g. [Removable Disk], etc.

For Windows

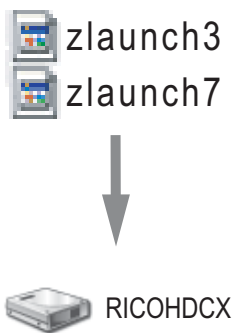

For Macintosh



9. Open [RICOHDCX] in [My Computer], and confirm that the firmware is copied as below.

Example of display in Windows

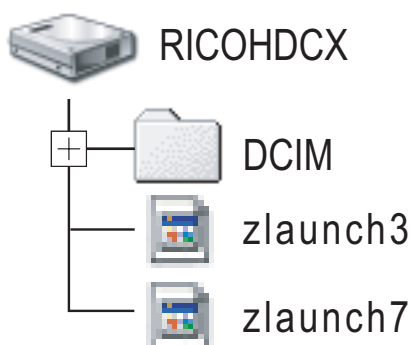

Example of display in Macintosh



10. For Windows

When the copying of the firmware is completed, double-click the [Safely Remove Hardware] icon in the task bar.

For Macintosh

Drag and drop the [RICOHDCX] icon to the [Trash] icon. Once the icon has disappeared, proceed to Step 14.



Caution

If you skip the procedures in Step 10, the firmware copy may not be successful.

11. Select [USB Mass Storage Device], and click [Stop].

12. Click [OK].

13. Click the [Close] button.

14. Turn the camera off, and disconnect the USB cable.

To copy the firmware using a card reader or a card writer to an SD memory card

- 1.** Copy the files [zlaunch3] and [zlaunch7] (created when the firmware was extracted) into the root directory of the SD memory card.
- 2.** Load the camera with the SD memory card which the firmware was copied to.

4. Update the firmware

1. Switch the camera's mode dial to SCENE.

2. While pressing the ADJ./OK button ▲, hold down the  (Playback) button for 2-3 seconds.

- A confirmation message for the firmware update is displayed on the picture display.

3. Press the ADJ./OK button ► to select [Yes], and press the ADJ./OK button.

- The firmware update starts, and the following message is displayed on the picture display.
[Checking rewrite file]
[Rewriting program]
The update is completed in about 40 seconds.
- The camera's power turns off automatically.

4. The camera automatically turns off and restarts.

 (Playback) Button Mode dial

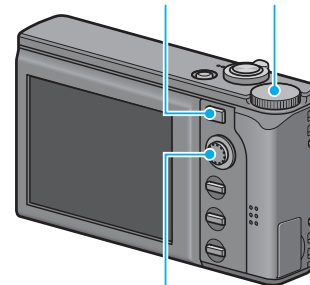

ADJ./OK Button



Note

- If the message [Incorrect rewriting file] is displayed and the camera is automatically turned off, check the camera model again and retry the update using the correct firmware.
- The firmware file copied to the SD memory card is deleted when you format the SD memory card. Delete the file if necessary.